

www.uniwin.co.uk



**UNI WINDOWS Ltd.**  
 Unit 6, Edgefield Industrial Est.  
 Loanhead, EH20 9TB  
 Tel.: 0131 448 3931

**ENTRANCE DOOR 92**  
 External door with drop-in aluminium  
 threshold Gutman

Version: 2	Scale: 1:2
Date: 23.03.17	Drawing: FZ1

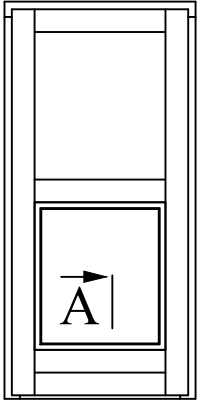

A

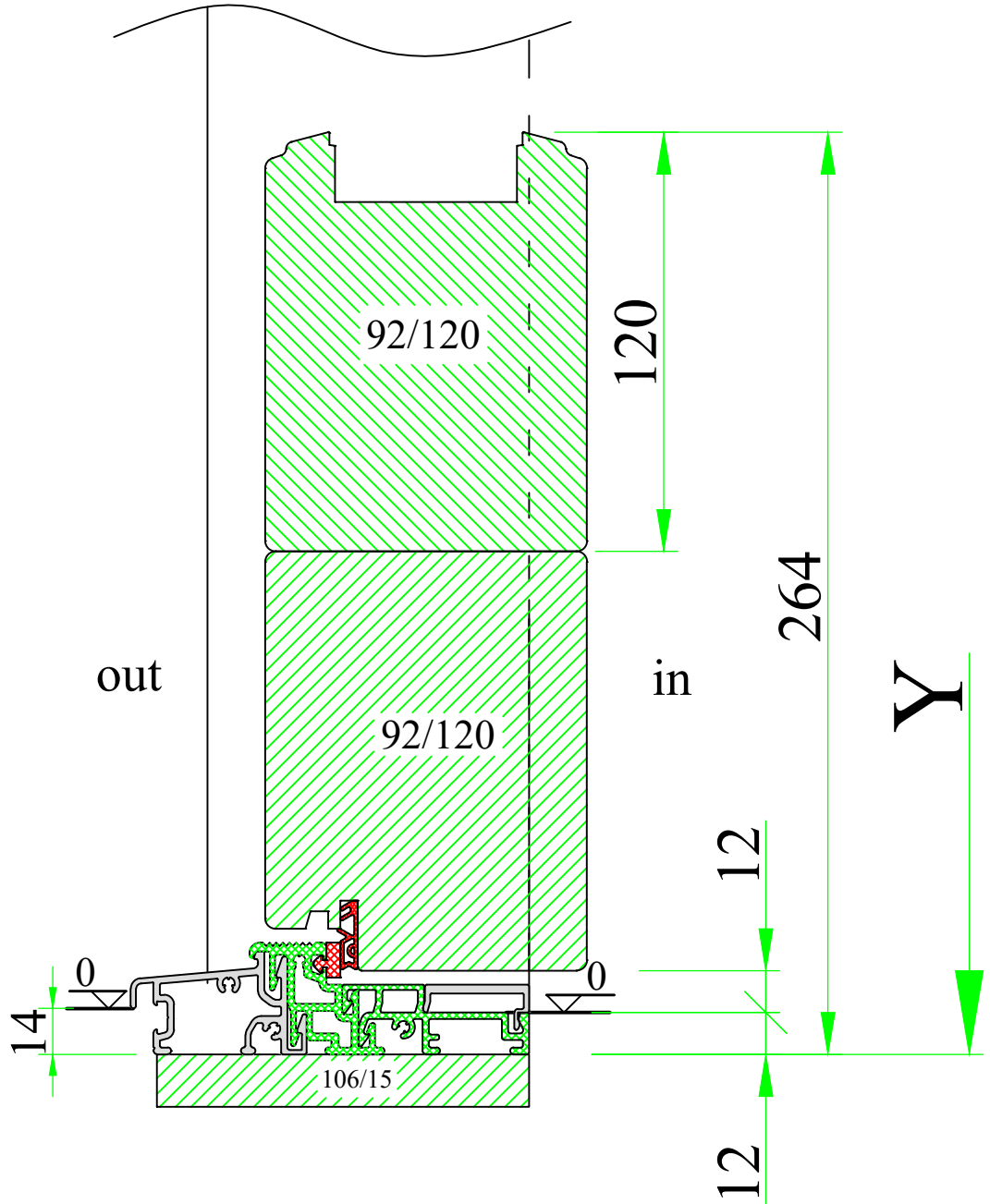

www.uniwin.co.uk



**UNI WINDOWS Ltd.**  
 Unit 6, Edgefield Industrial Est.  
 Loanhead, EH20 9TB  
 Tel.: 0131 448 3931

ENTRANCE DOOR 92

External door with aluminium threshold  
 Wesser New

Version:  
2

Date:  
23.03.17

Scale:  
1:2

Drawing:  
FZ2

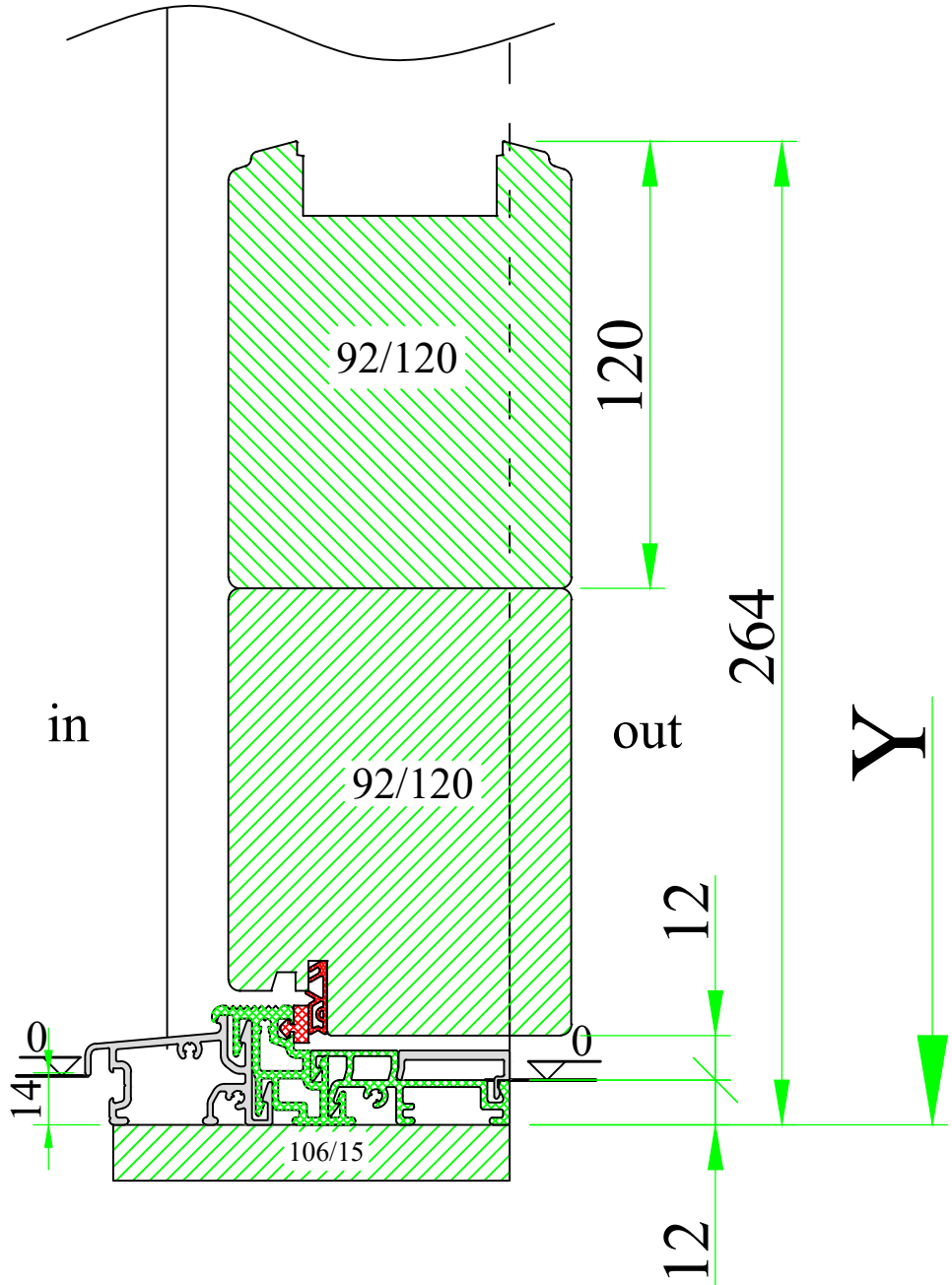
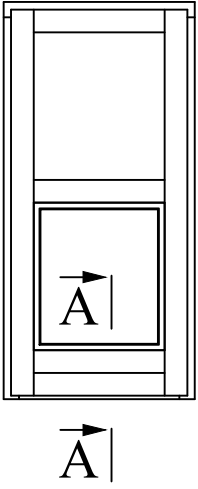

**UNI WINDOWS Ltd.**  
 Unit 6, Edgefield Industrial Est.  
 Loanhead, EH20 9TB  
 Tel.: 0131 448 3931

**ENTRANCE DOOR 92**  
 Outward opening external door with  
 aluminium threshold Wesser New

Version: 2	Scale: 1:2
Date: 23.03.17	Drawing: FZ2-1

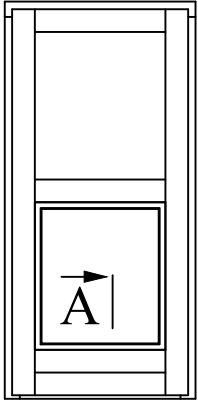

A

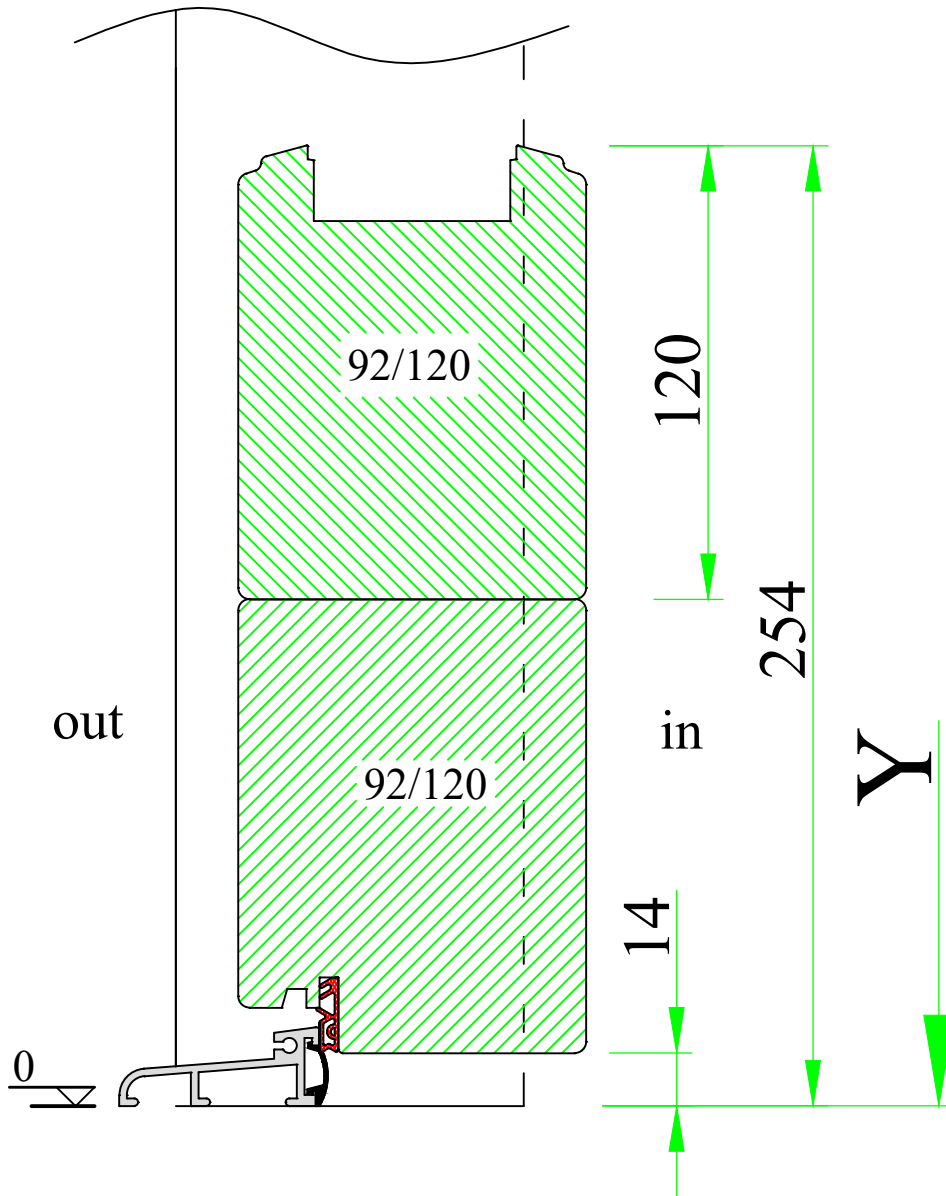

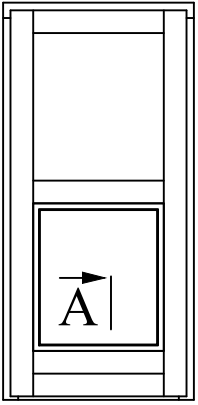

A

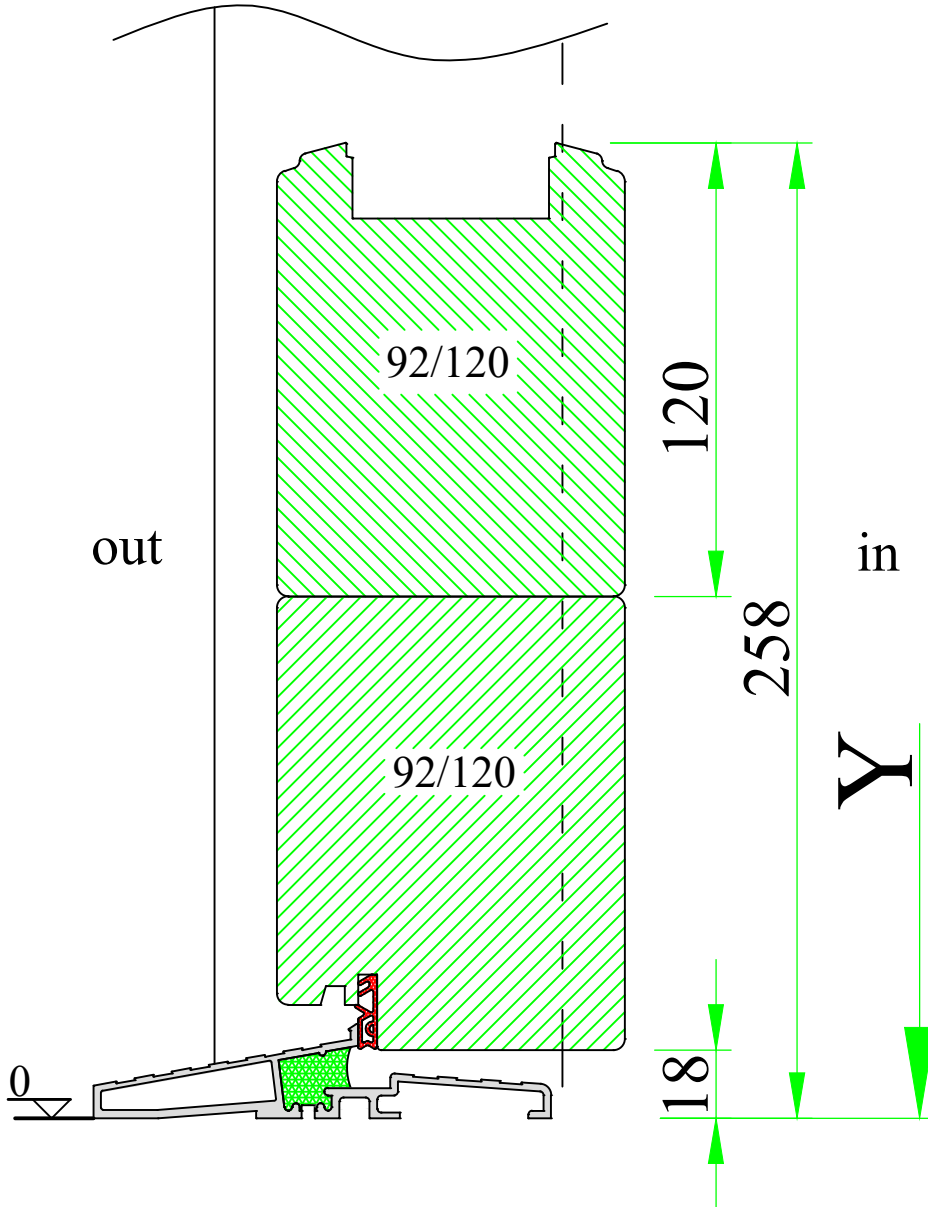

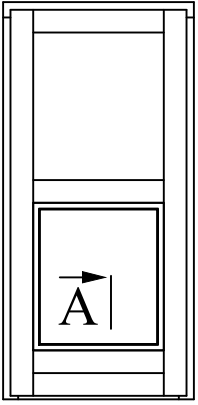

A

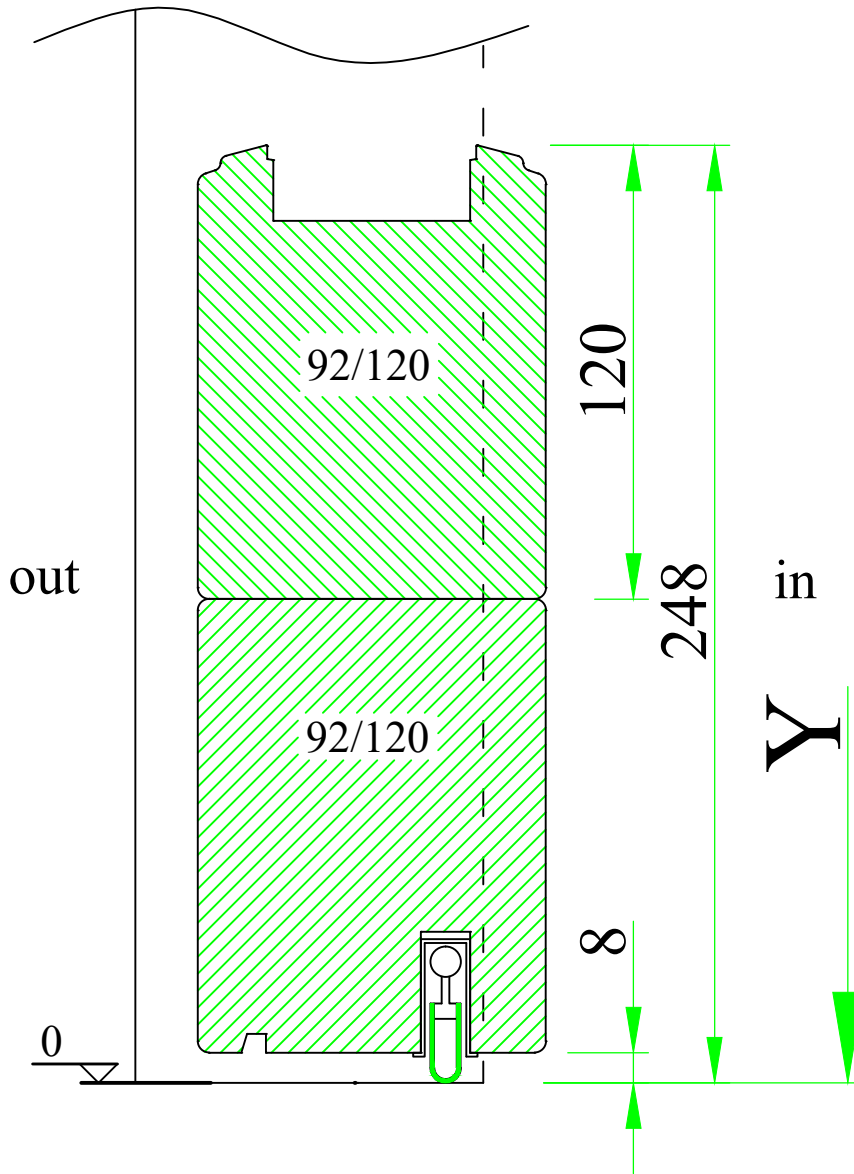

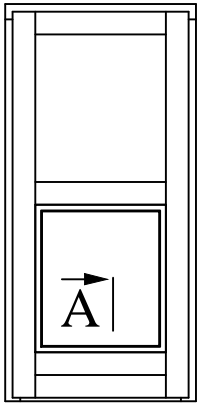

A

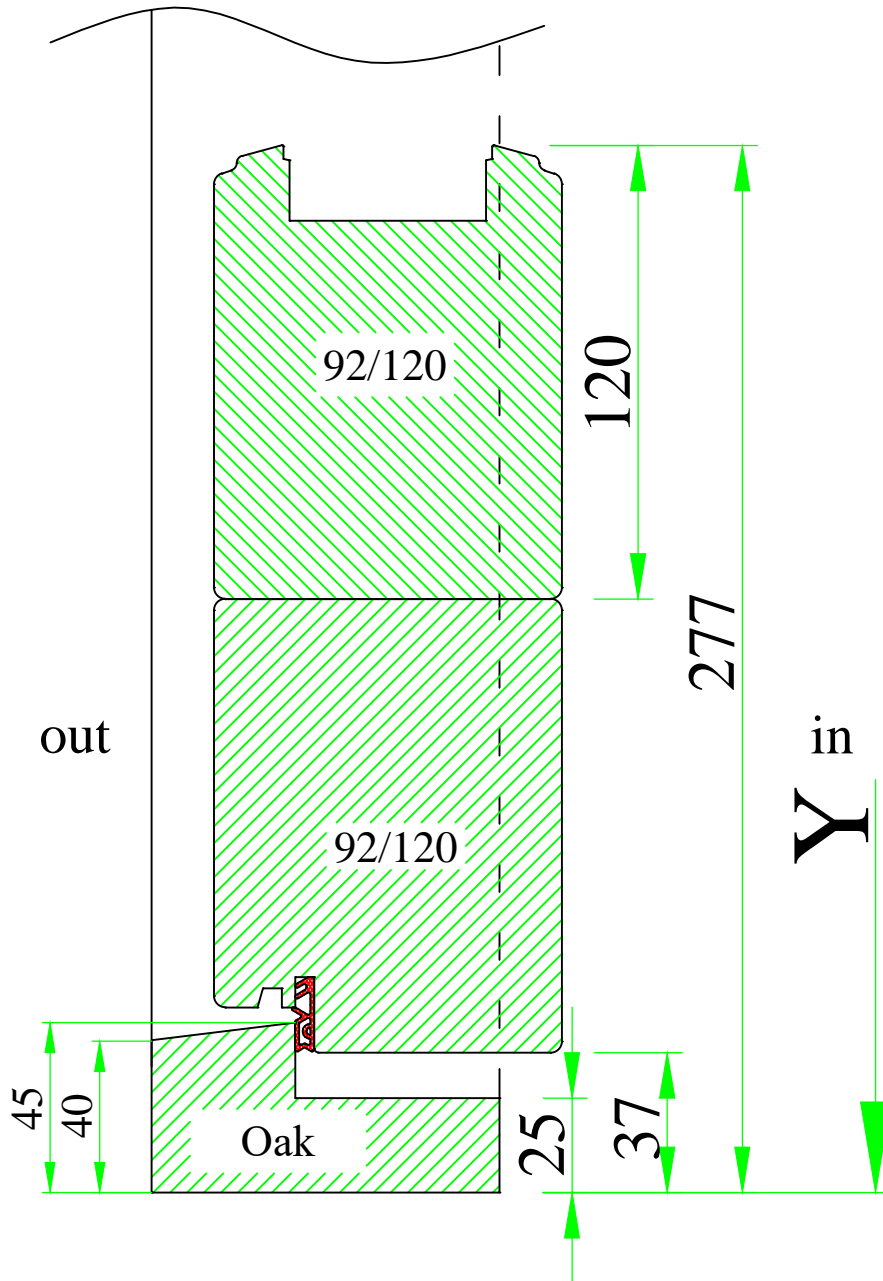

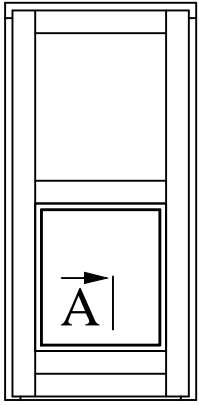

A

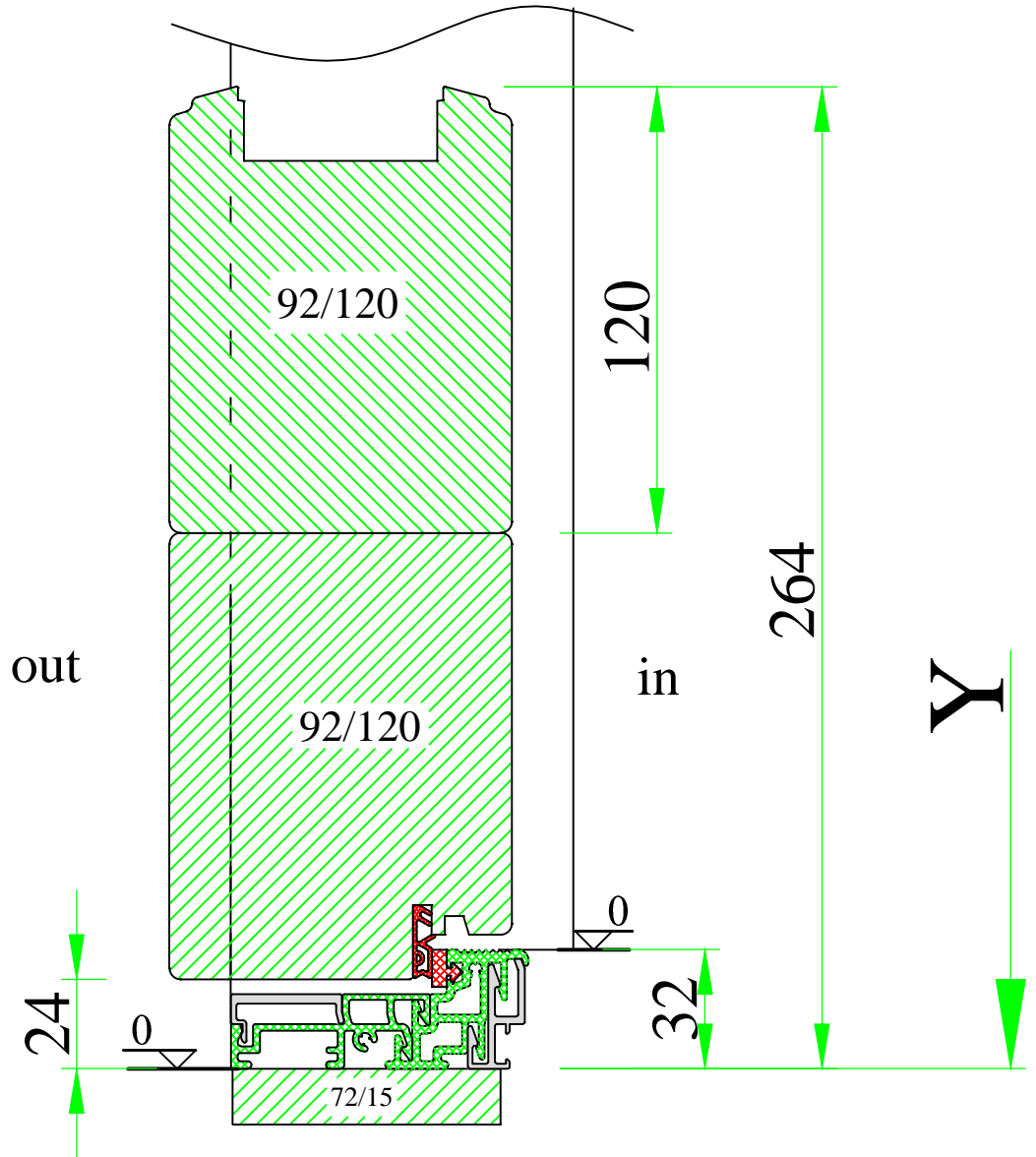

www.uniwin.co.uk



**UNI WINDOWS Ltd.**  
 Unit 6, Edgefield Industrial Est.  
 Loanhead, EH20 9TB  
 Tel.: 0131 448 3931

ENTRANCE DOOR 92

Outward opening external door with  
 aluminium threshold Wesser- A

Version:  
2

Date:  
23.03.17

Scale:  
1:2

Drawing:  
FZ7



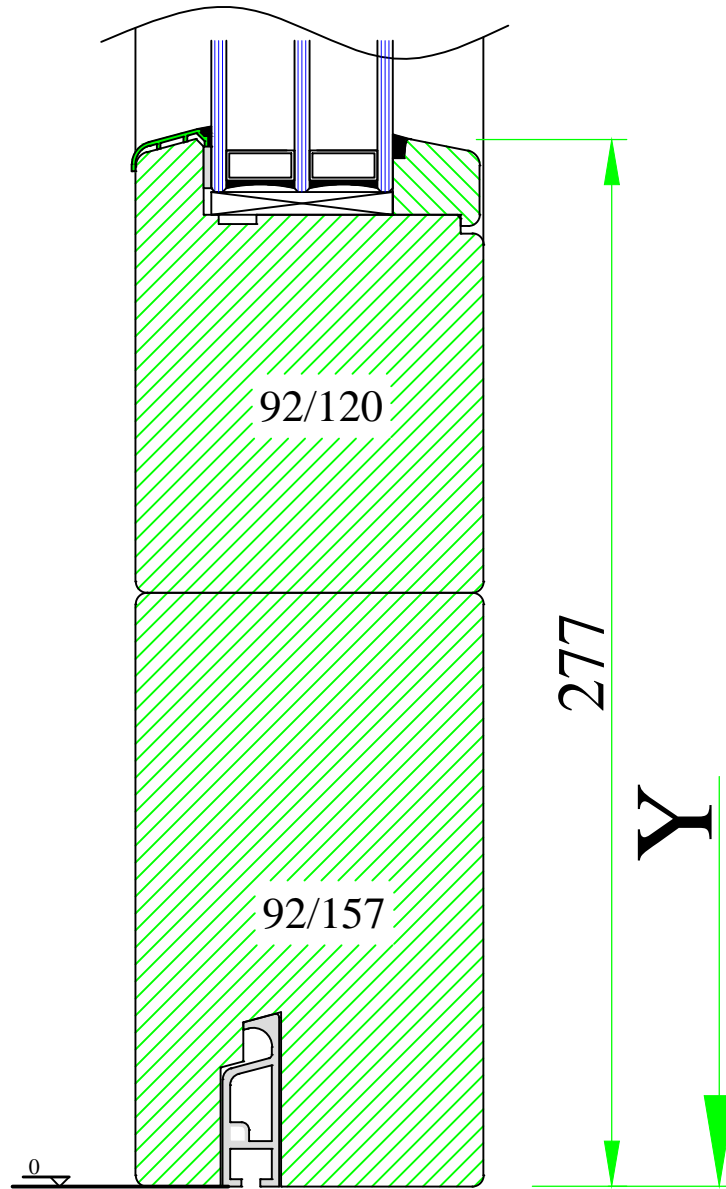
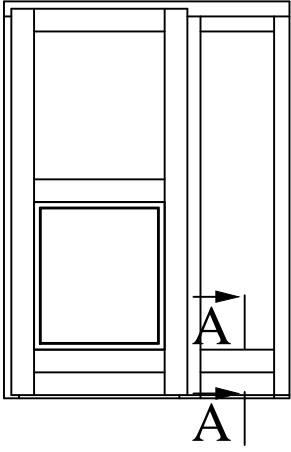

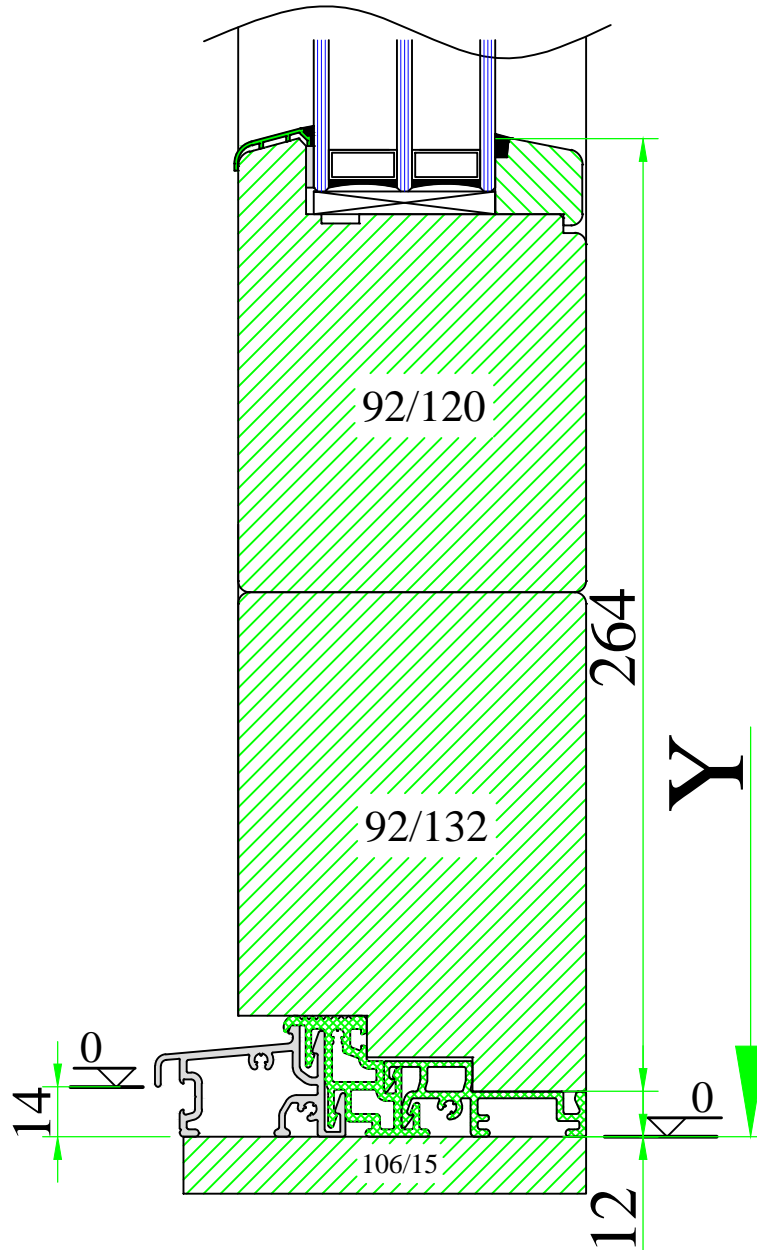
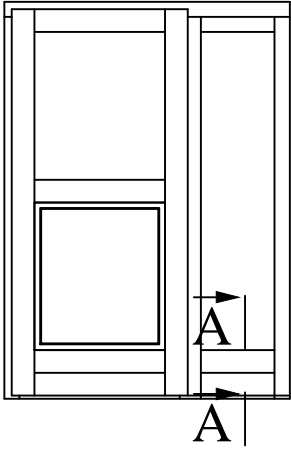

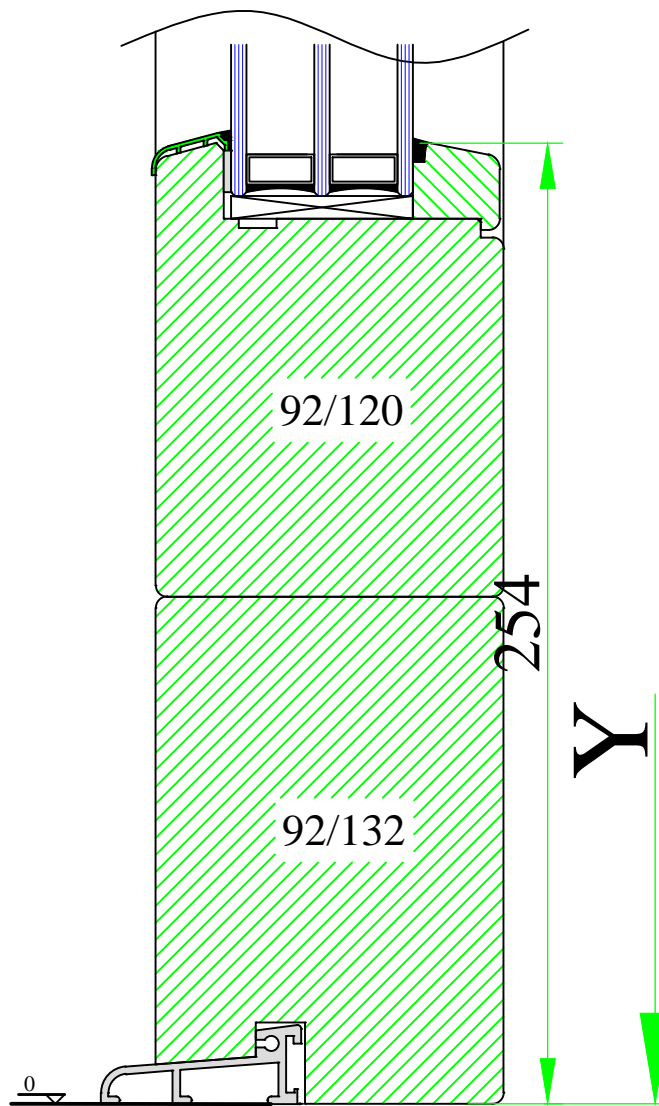
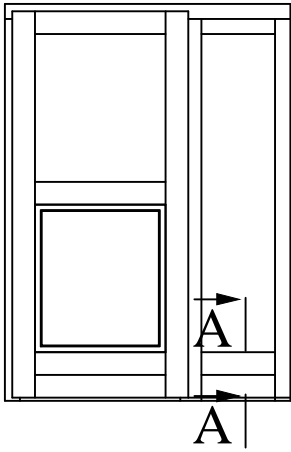

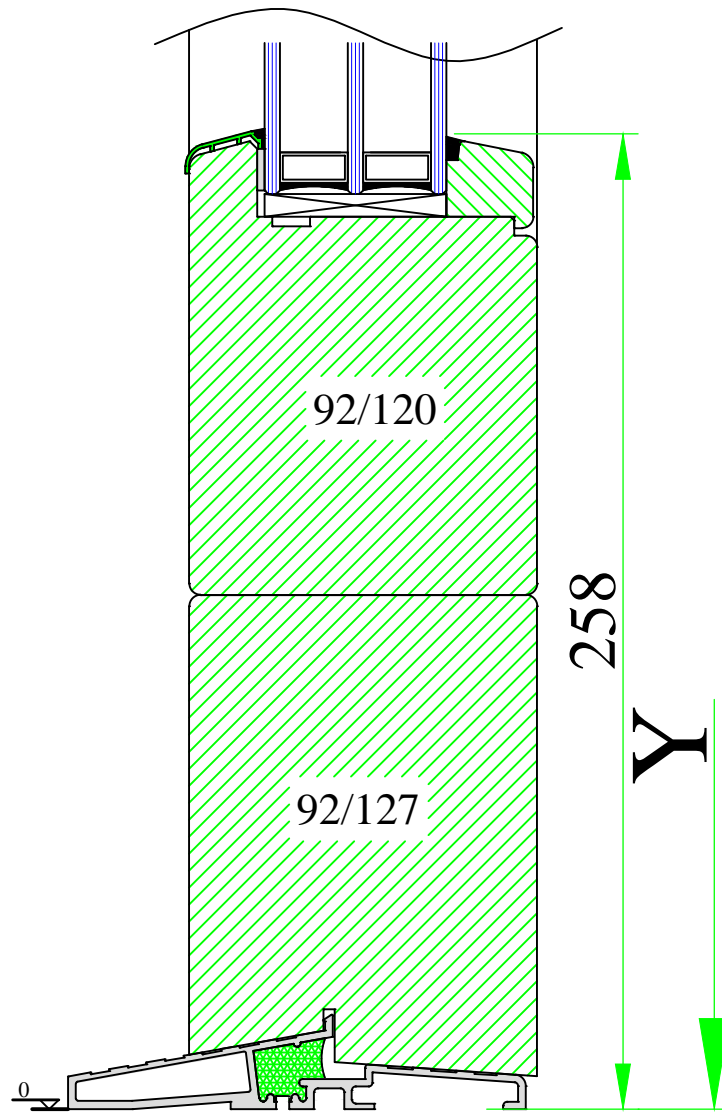
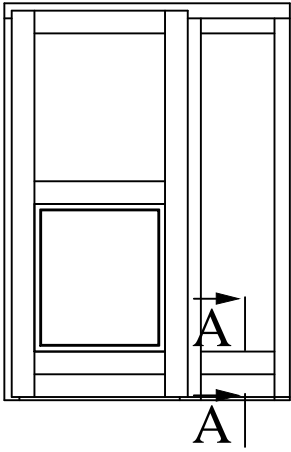

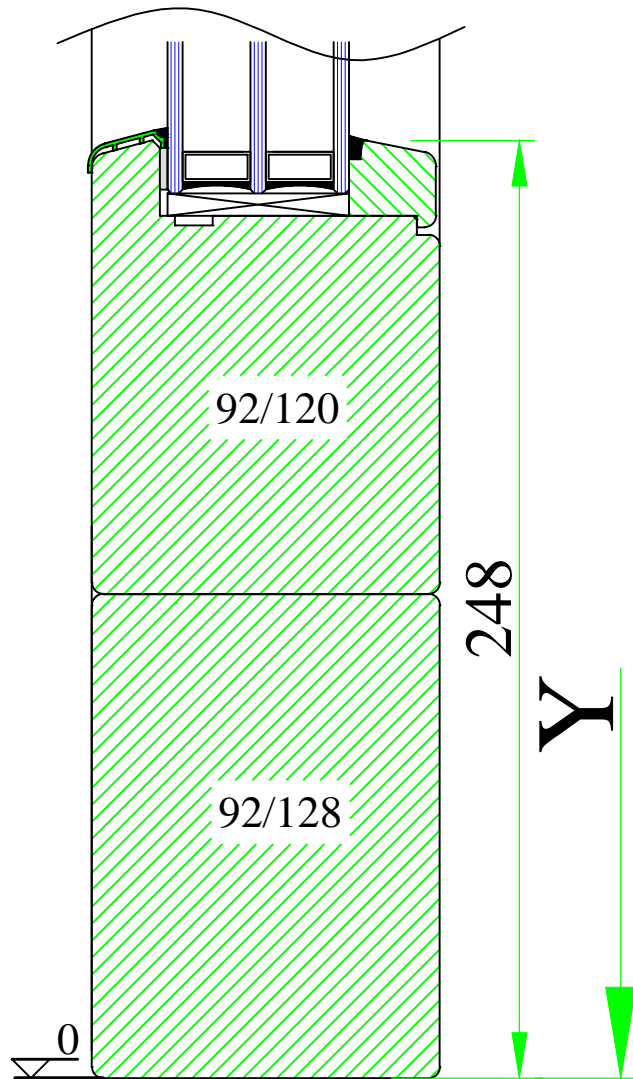
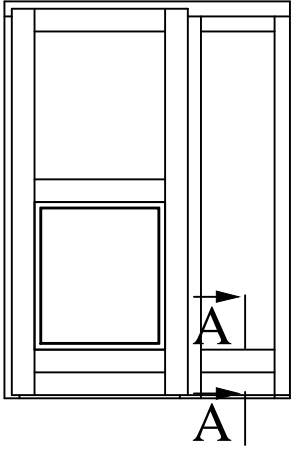

A

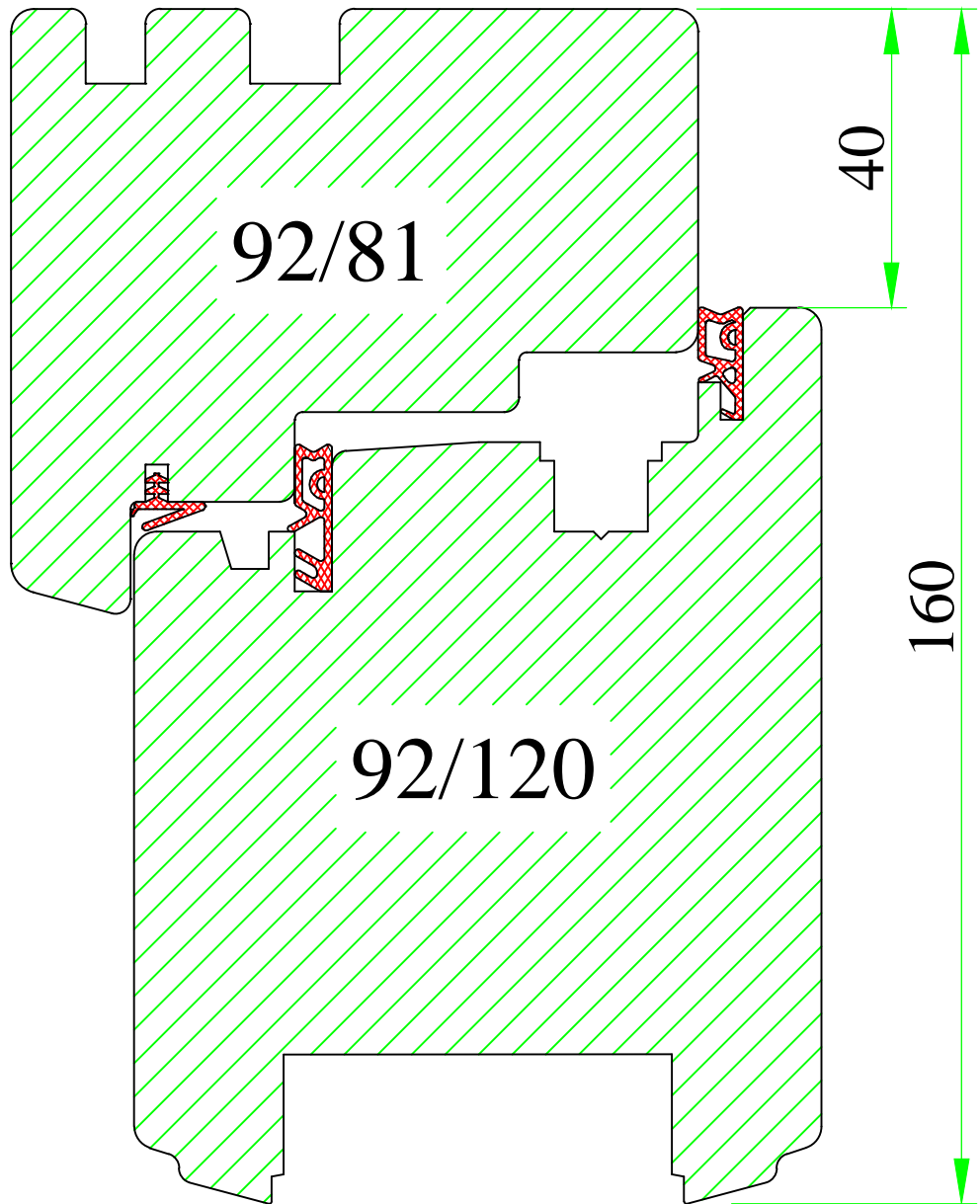
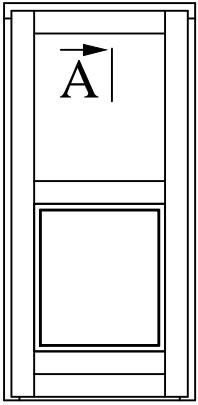

# STANDARD

FZ/21

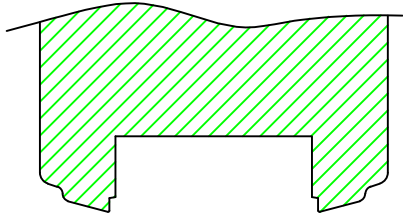

FZ/21/1

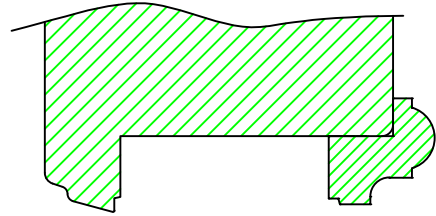

# OPTIONS

FZ/21/2

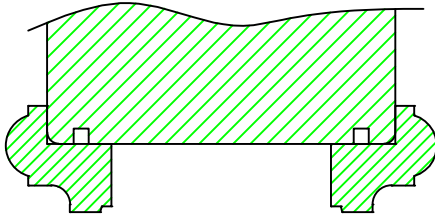

FZ/21/3

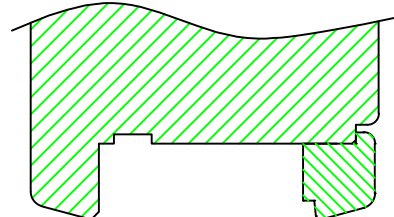

THERMO

FZ/21/4

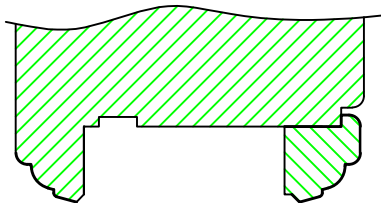

Retro

FZ/21/5

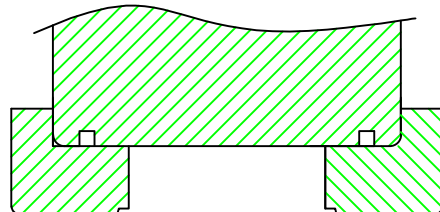

Deco, Modern

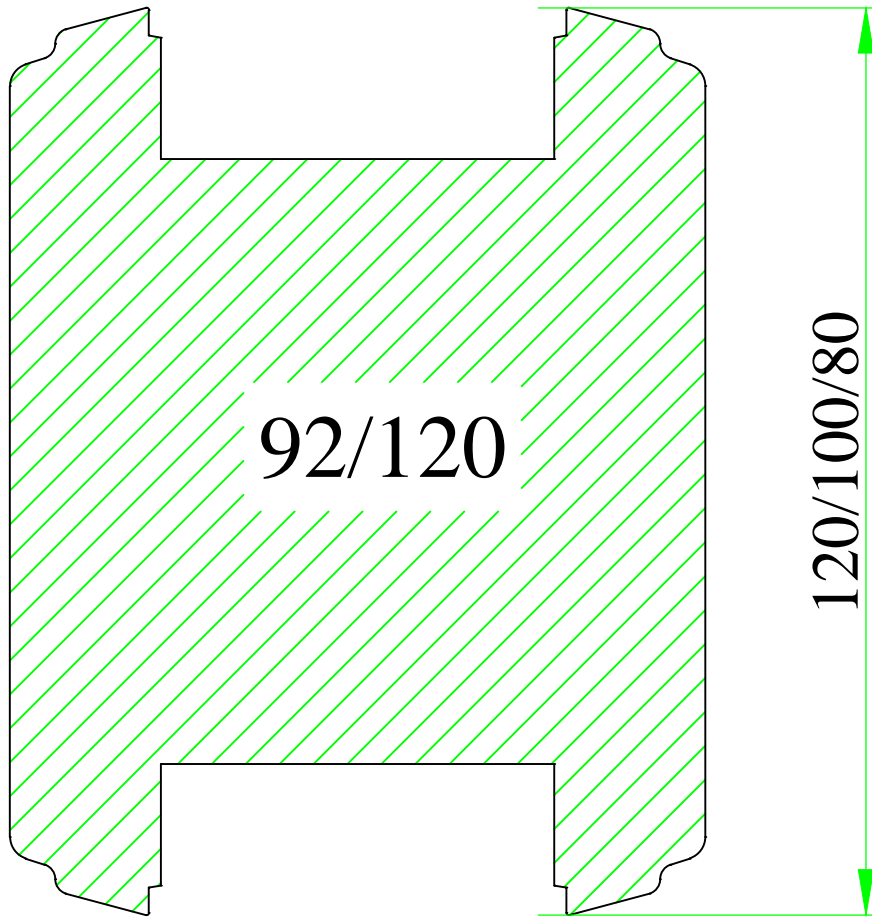
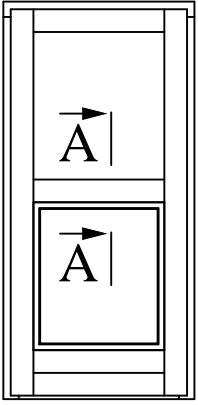

**UNI WINDOWS Ltd.**  
Unit 6, Edgefield Industrial Est.  
Loanhead, EH20 9TB  
Tel.: 0131 448 3931

ENTRANCE DOOR 92  
Transom bar 80/100/120mm

Version: 2	Scale: 1:1
Date: 23.03.17	Drawing: FZ22



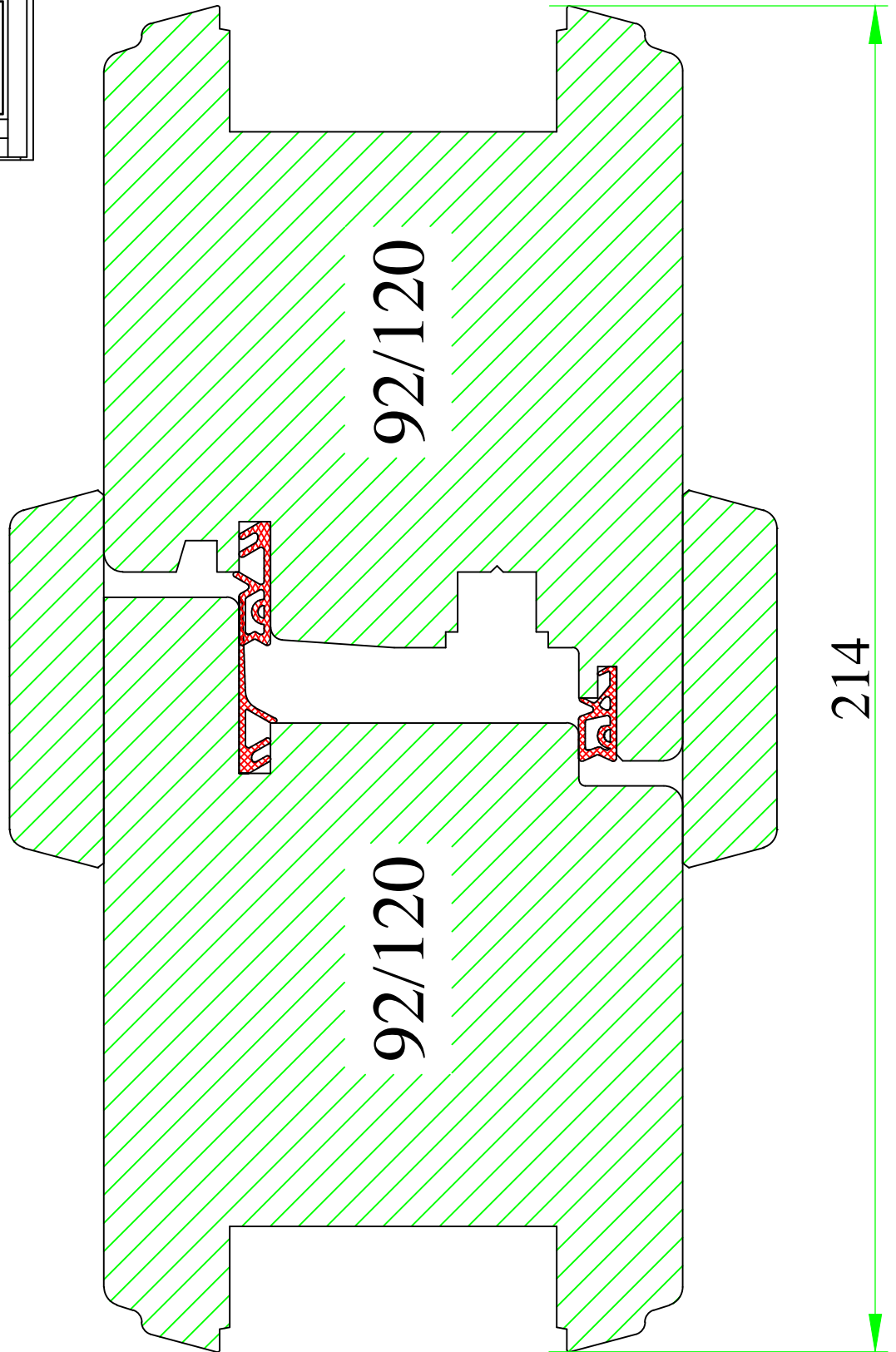
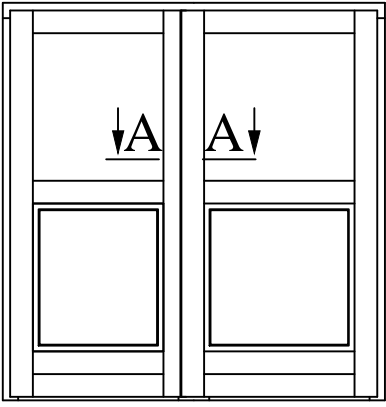

www.uniwin.co.uk



**UNI WINDOWS Ltd.**  
 Unit 6, Edgefield Industrial Est.  
 Loanhead, EH20 9TB  
 Tel.: 0131 448 3931

Flying mulion detail

ENTRANCE DOOR 92

Version:  
2

Date:  
23.03.17

Scale:  
1:1

Drawing:  
FZ24

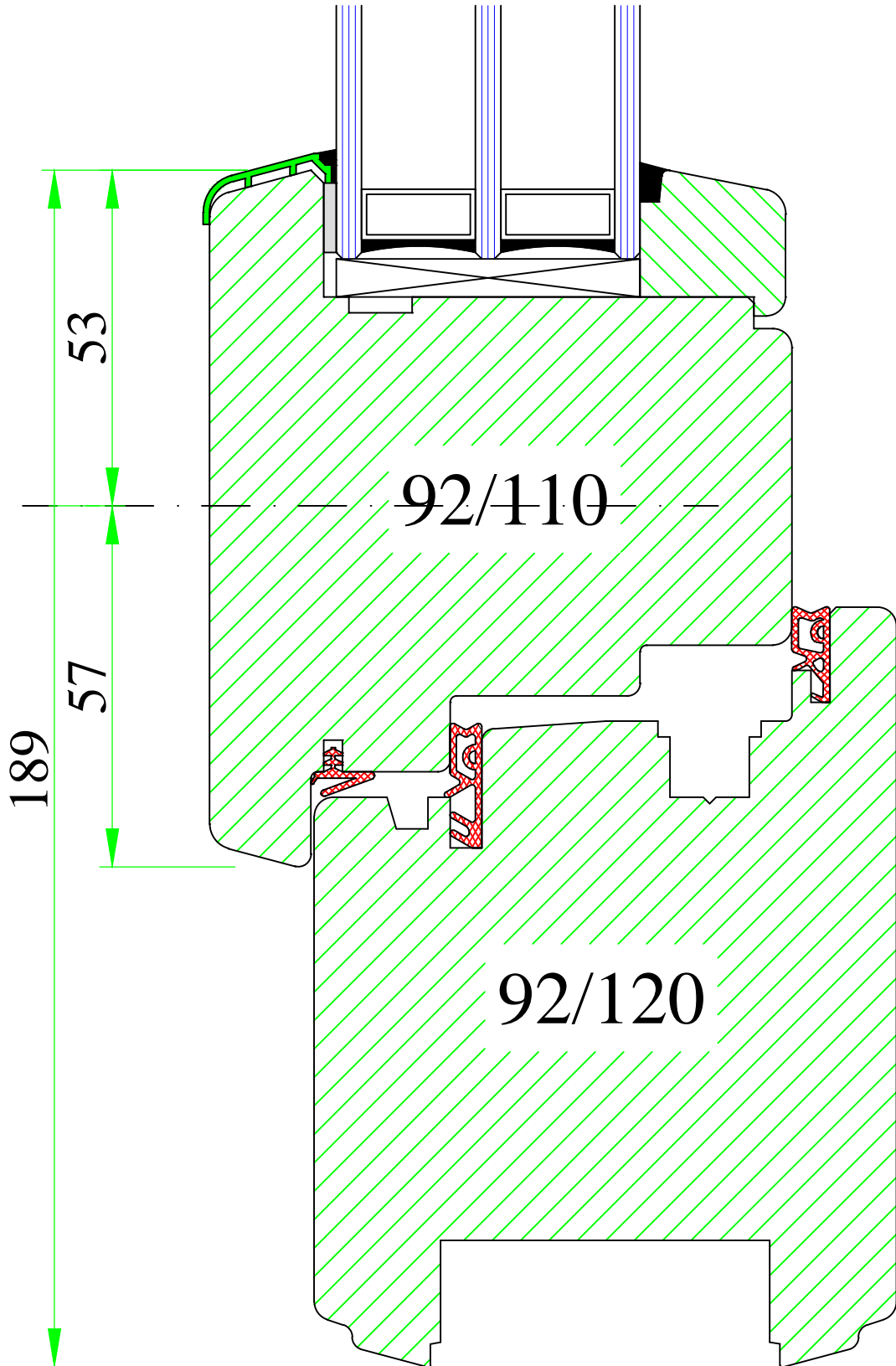
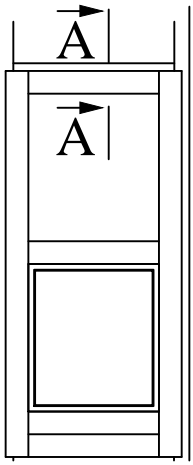

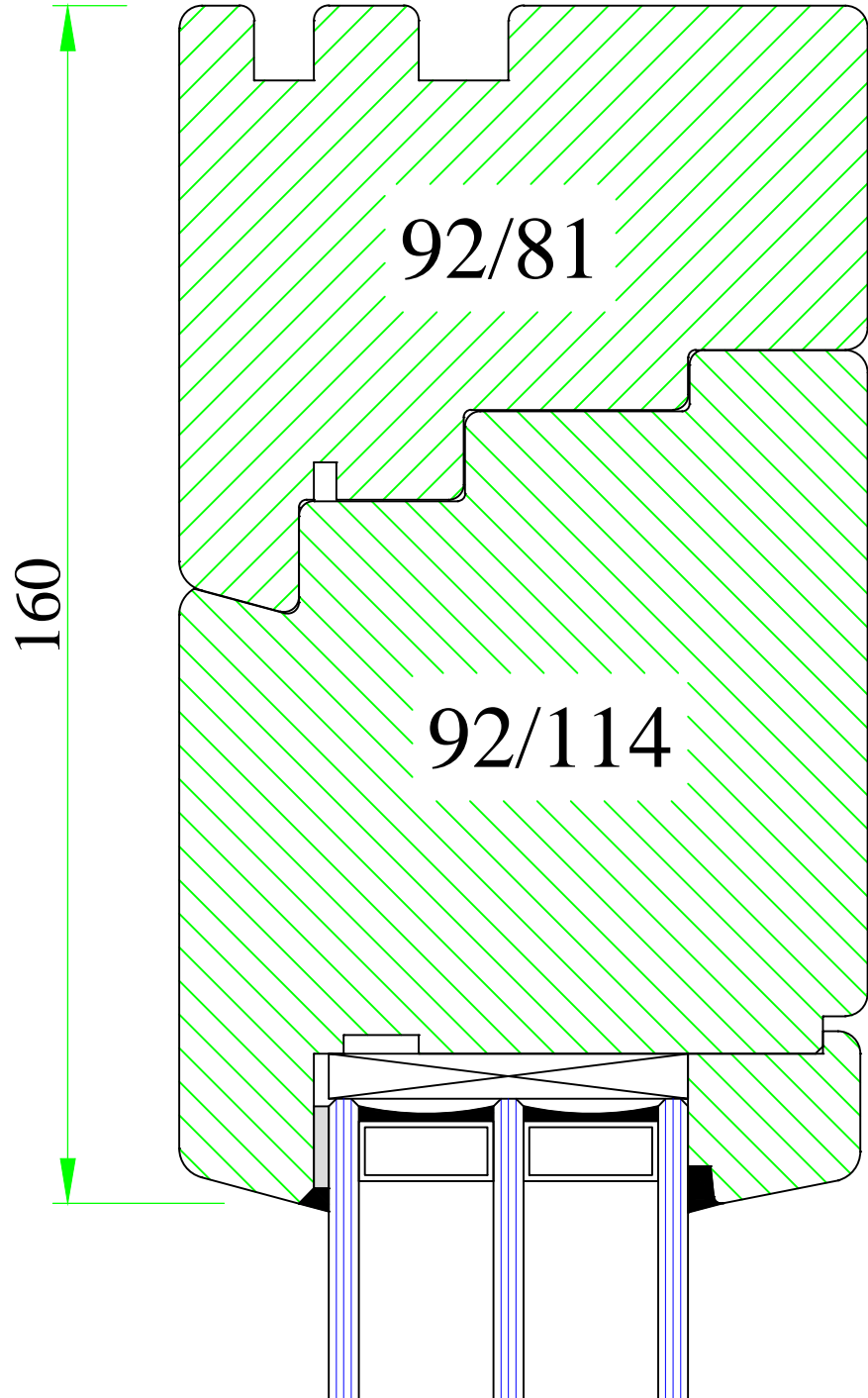
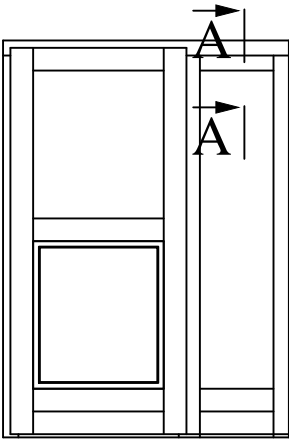

www.uniwin.co.uk



**UNI WINDOWS Ltd.**  
 Unit 6, Edgefield Industrial Est.  
 Loanhead, EH20 9TB  
 Tel.: 0131 448 3931

ENTRANCE DOOR 92  
 Side light glass line alignment - top frame

Version: 2	Scale: 1:2
Date: 23.03.17	Drawing: FZ27

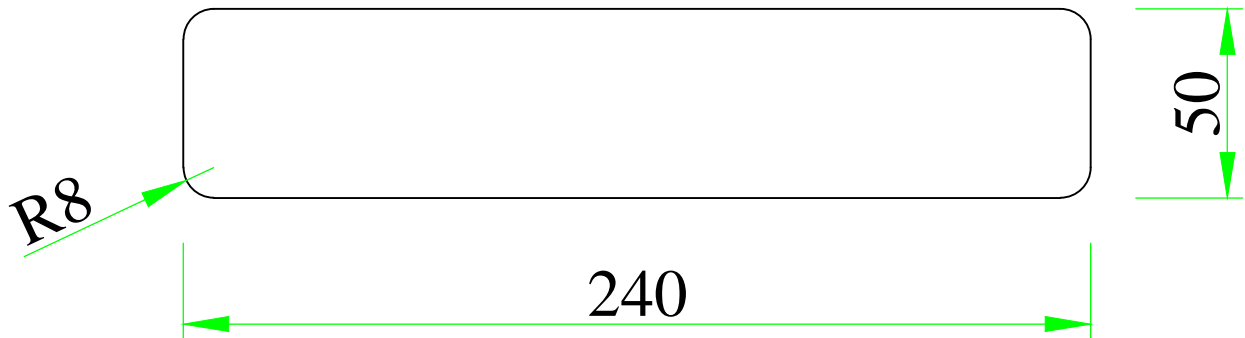
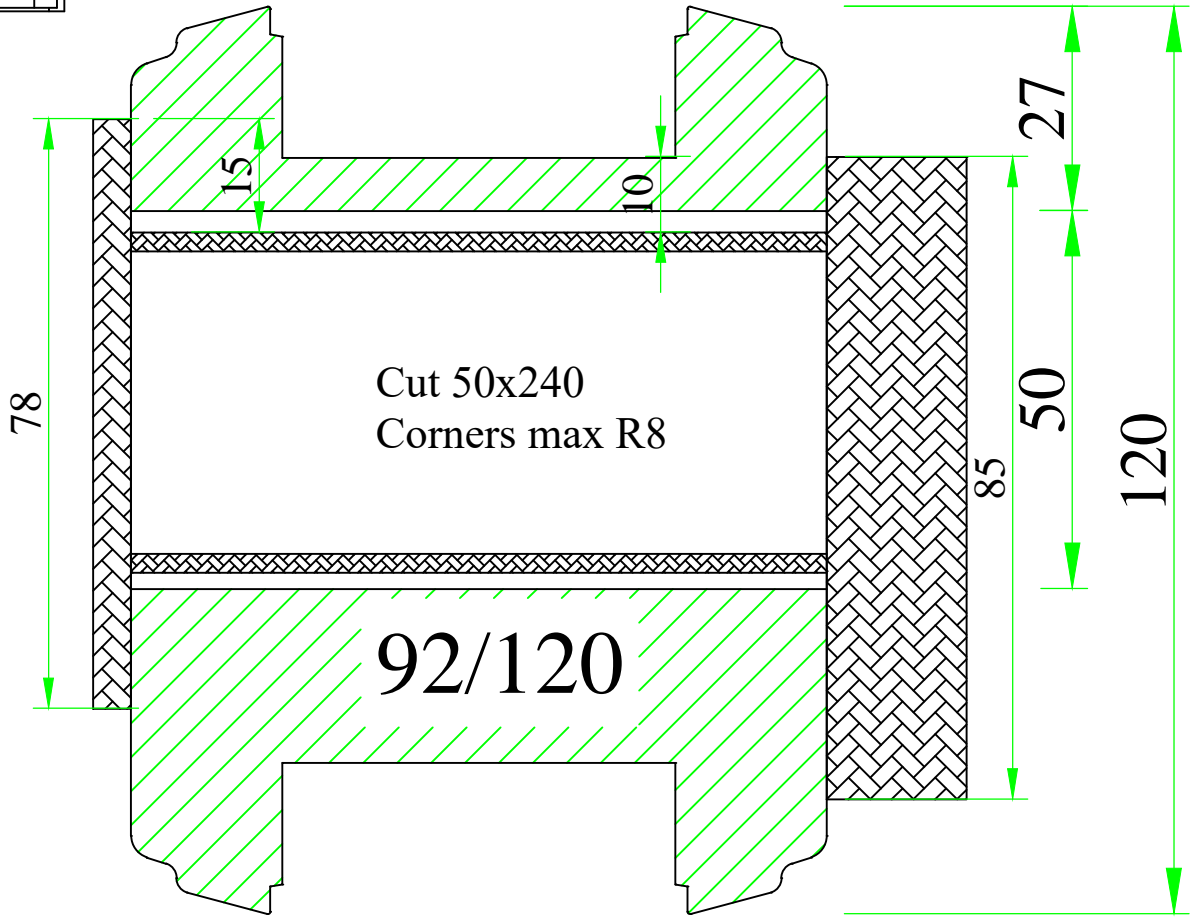
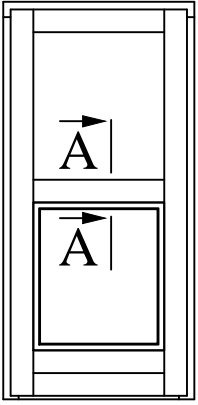

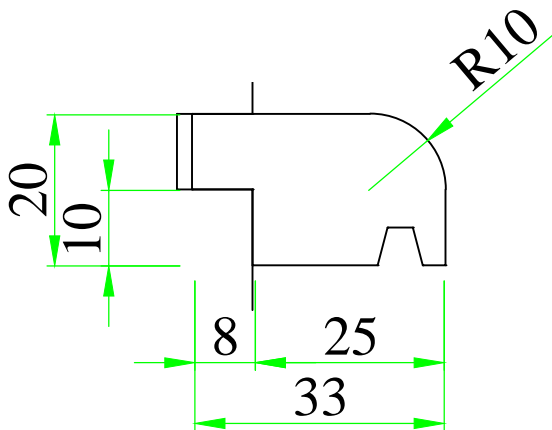
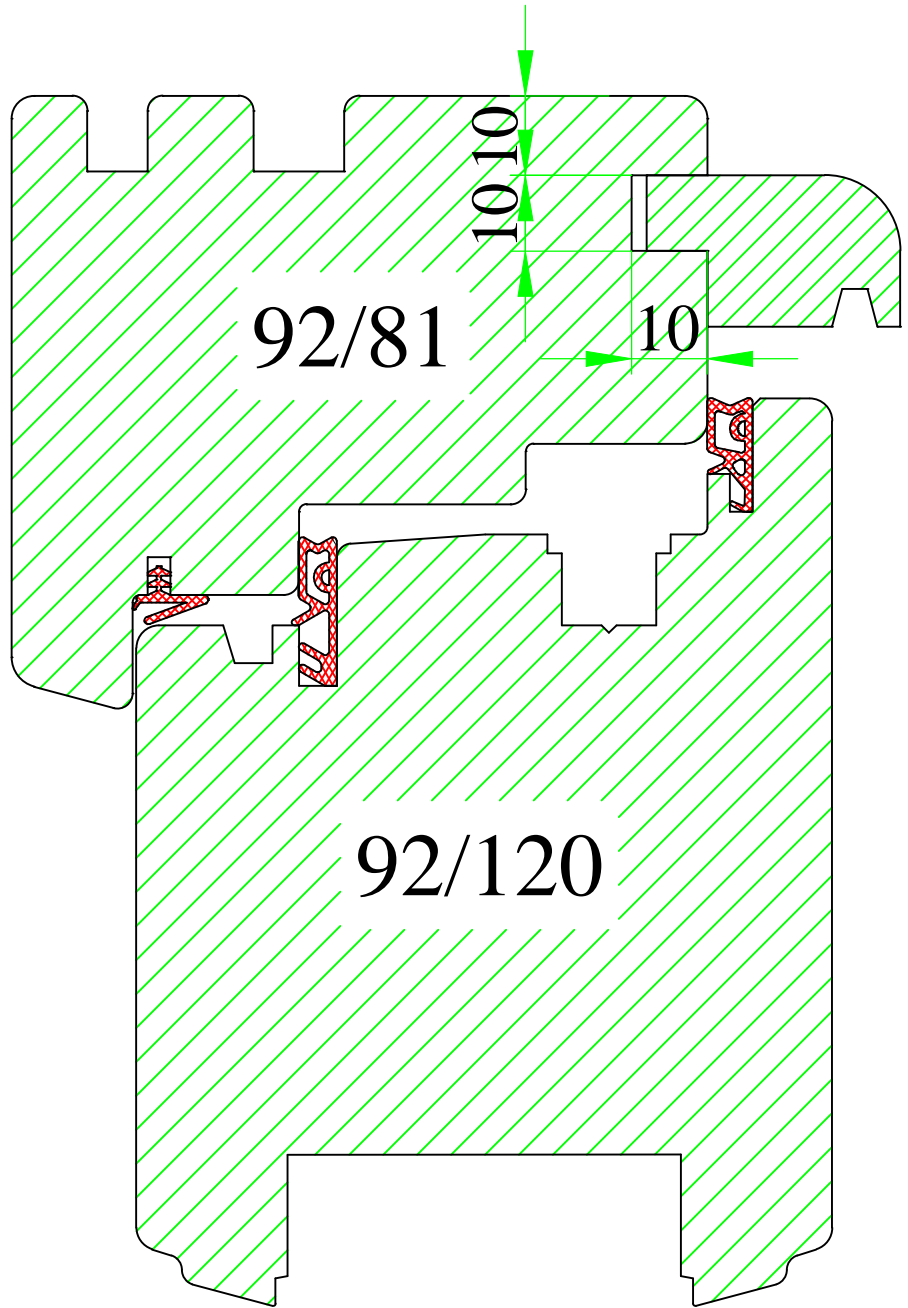
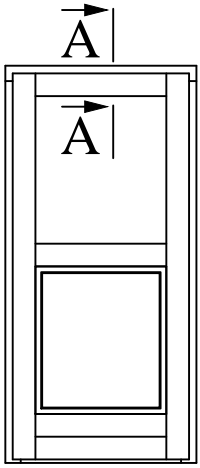

**UNI WINDOWS Ltd.**  
 Unit 6, Edgefield Industrial Est.  
 Loanhead, EH20 9TB  
 Tel.: 0131 448 3931

**ENTRANCE DOOR 92**  
 Outward opening door - external drip above  
 the leaf

Version: 2	Scale: 1:1
Date: 23.03.17	Drawing: FZ34

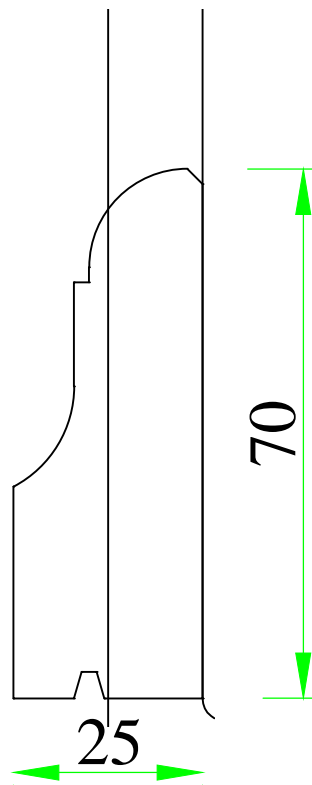
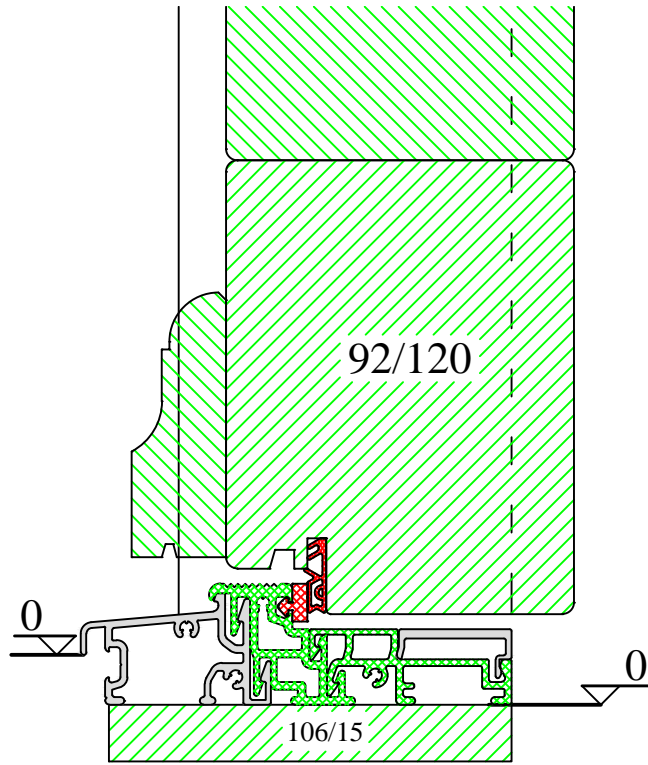
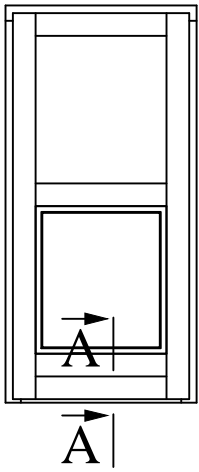

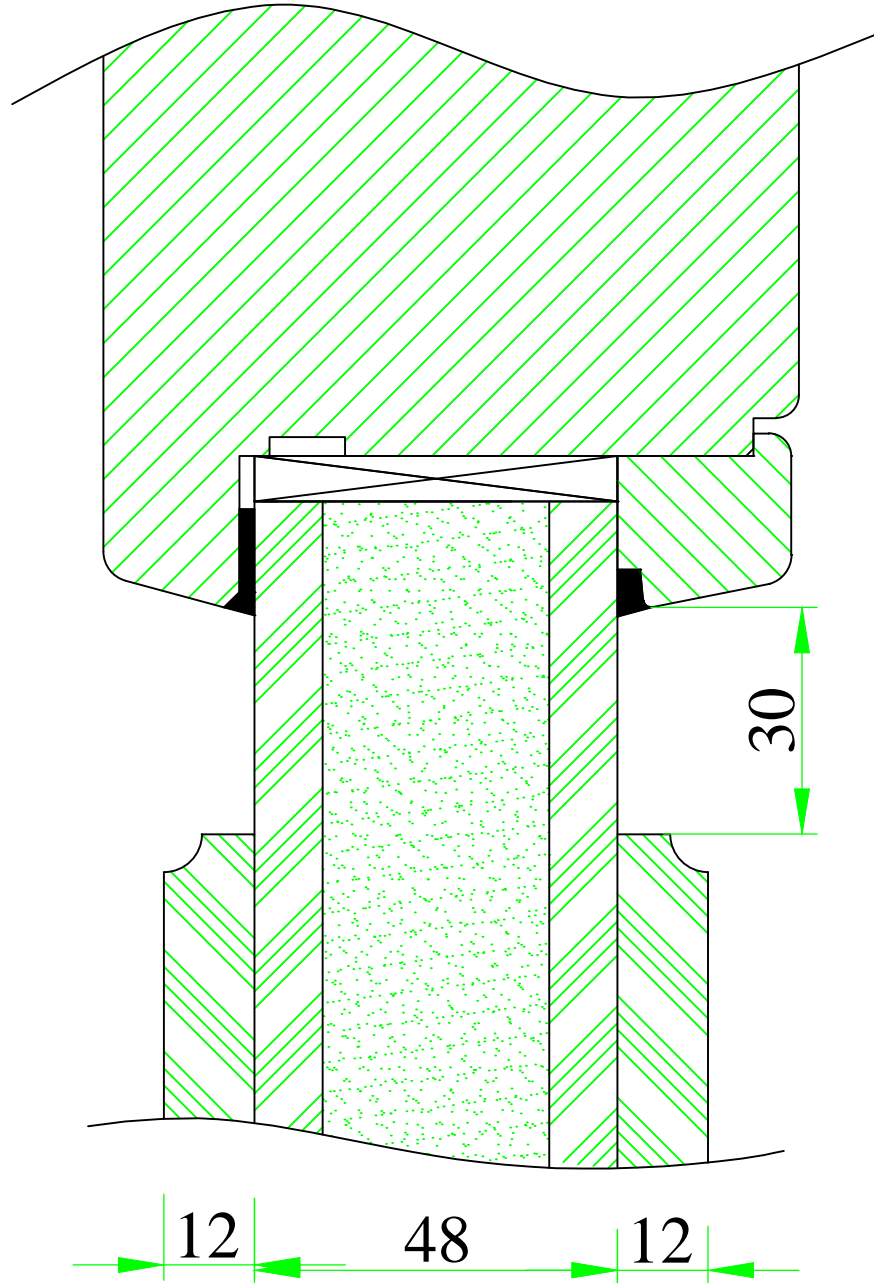
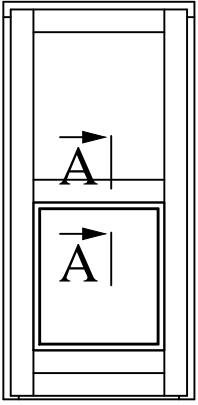

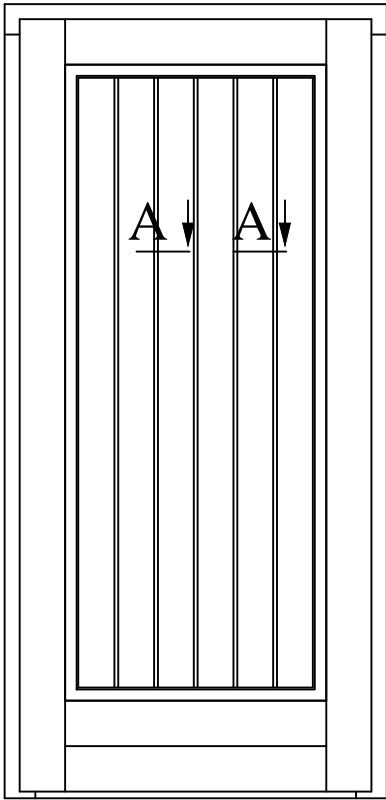

type A

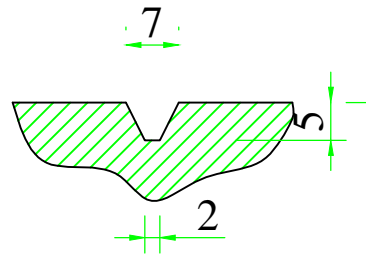

type B

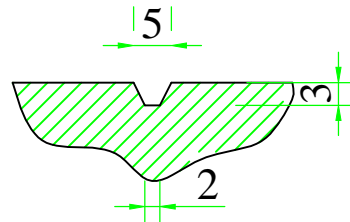

type C

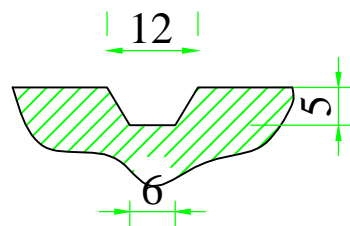



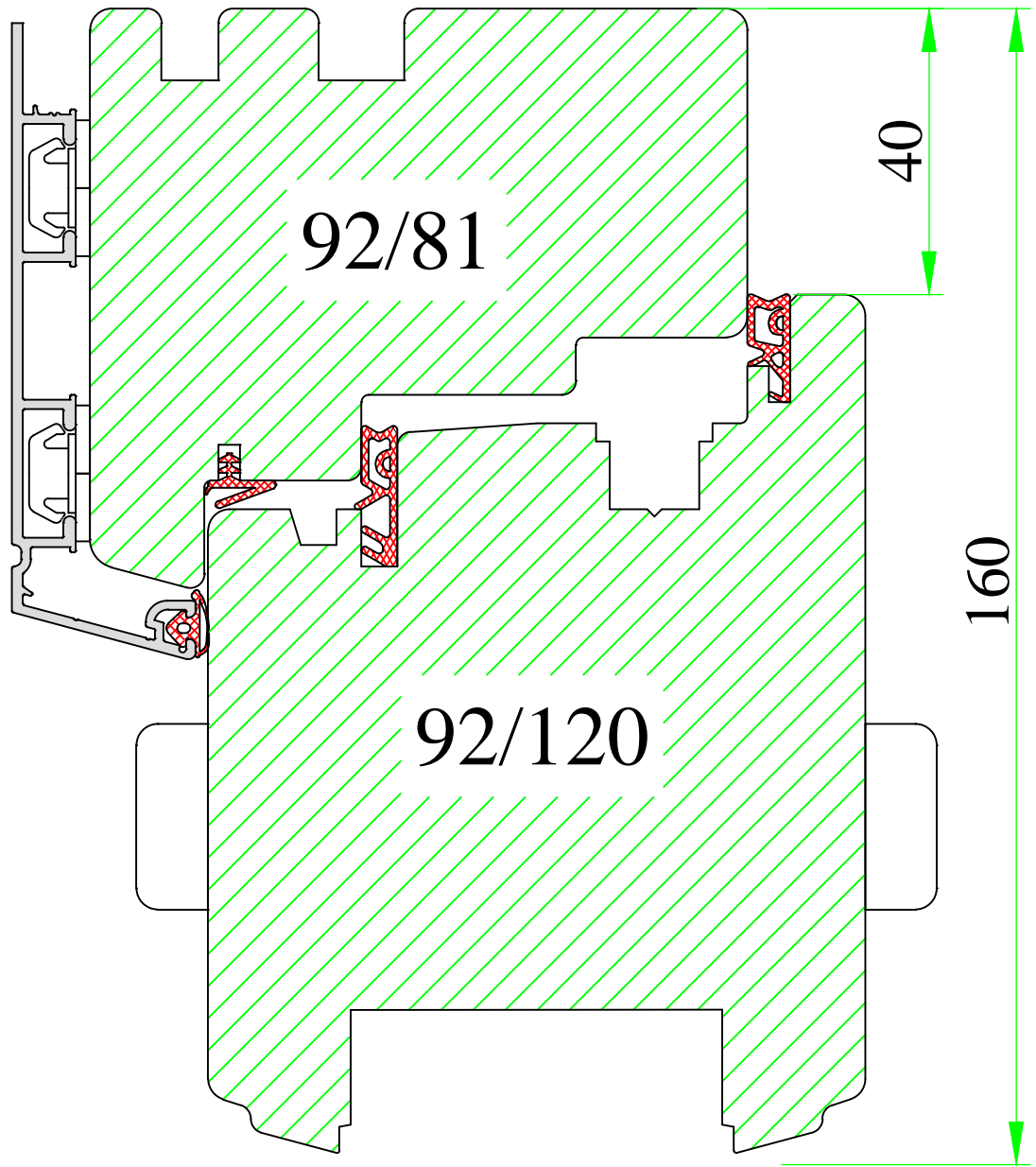
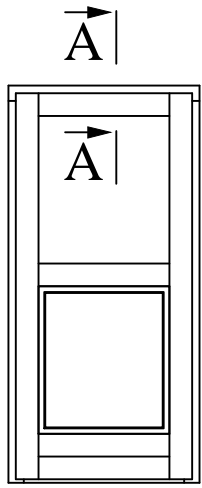

www.uniwin.co.uk



**UNI WINDOWS Ltd.**  
 Unit 6, Edgefield Industrial Est.  
 Loanhead, EH20 9TB  
 Tel.: 0131 448 3931

**ENTRANCE DOOR 92**  
 Hybrid door - alu clad on door frame with  
 wooden door

Version:  
2  
 Date:  
23.03.17

Scale:  
1:1  
 Drawing:  
FZ39

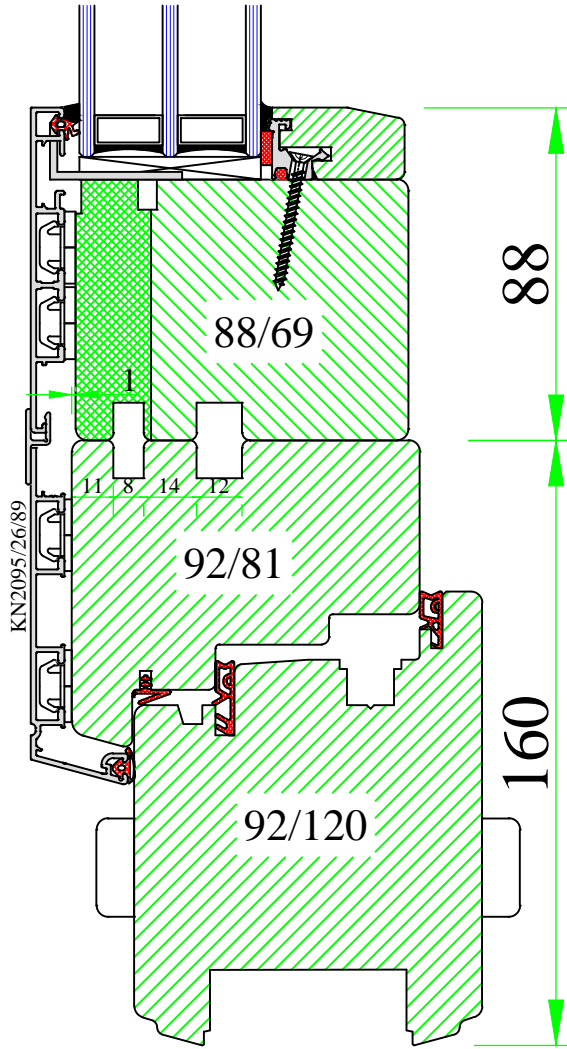

**UNI WINDOWS Ltd.**  
 Unit 6, Edgefield Industrial Est.  
 Loanhead, EH20 9TB  
 Tel.: 0131 448 3931

**ENTRANCE DOOR 92**  
 Hybrid door to alu clad window connection

Version: 2	Scale: 1:2
Date: 23.03.17	Drawing: FZ39-1

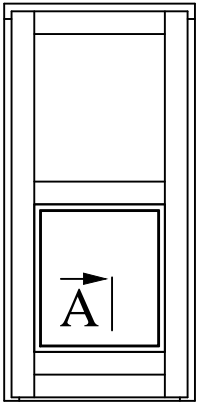

A

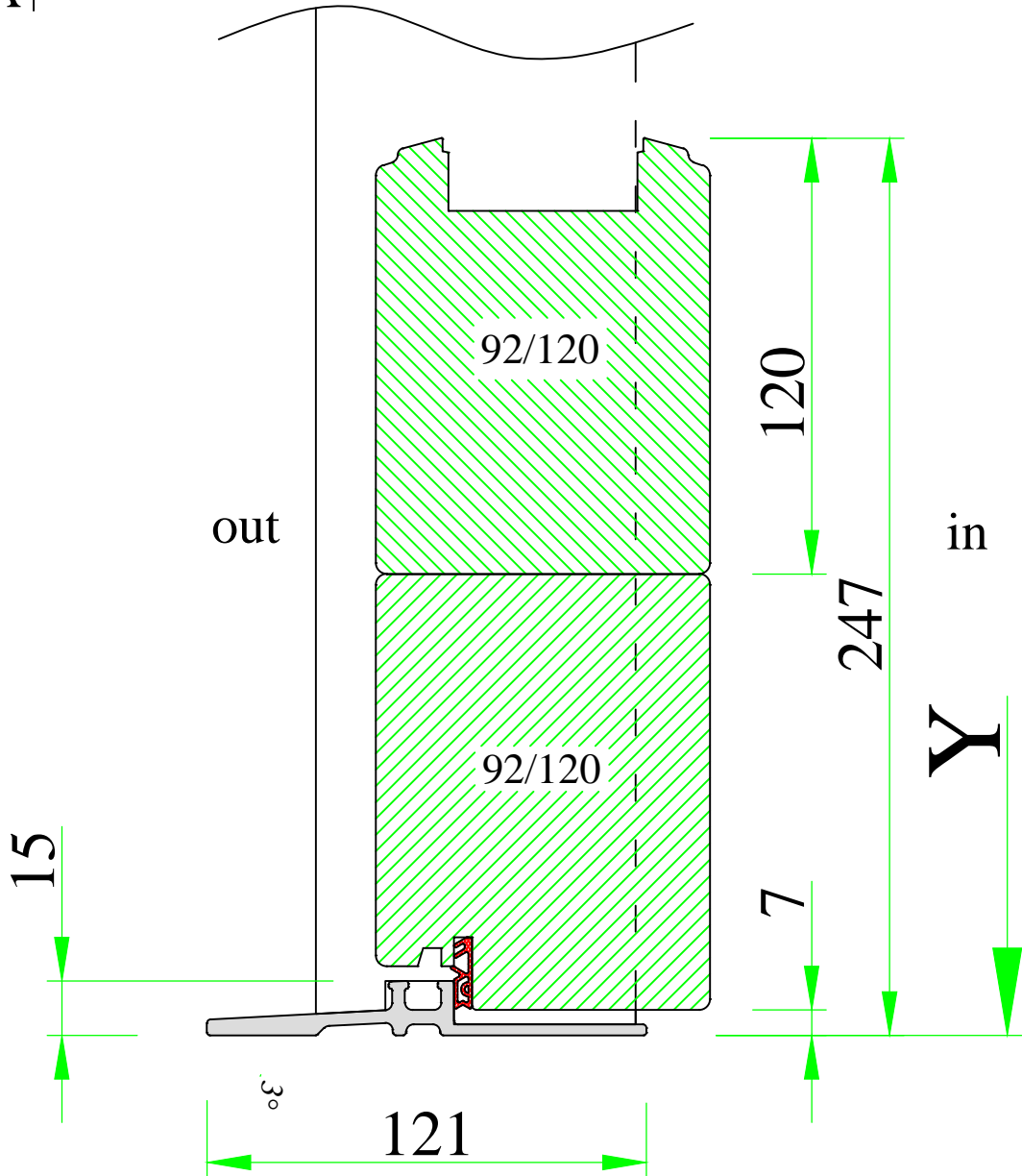

www.uniwin.co.uk



**UNI WINDOWS Ltd.**  
 Unit 6, Edgefield Industrial Est.  
 Loanhead, EH20 9TB  
 Tel.: 0131 448 3931

**ENTRANCE DOOR 92**  
 External door with d aluminium  
 threshold ULT

Version: 2	Scale: 1:2
Date: 23.03.17	Drawing: FZ40